

COMAX® P - Standard types

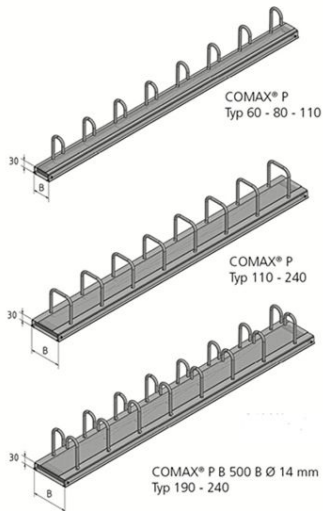

For faster execution of reinforcement joints

Standard length 1.25 m, height of the box: 30 mm

Significant advantages for the planner:

Excellent concrete bonding owing to perforated beaded strip

Significant advantages on the building site:

COMAX® P speeds up completion of shuttering owing to tear-off cover

- no tools needed

COMAX® P - KOMO certified

COMAX® P - robust and very strong

COMAX® P is highly compatible with the BETOMAX® injection system

Practically no restriction of injected material

DIN 1045-1 states that the load capacity utilization of casings must not exceed 80%

Agenda:

B = Type/strip width/element width

l = Anchoring length

b = Stirrup width

h = Stirrup height

e = Stirrup spacing

Technical data

Agenda:

B = type/sheet width/element width

l = anchorage length

b = temple width

h = hoop height

e = stirrup distance

COMAX® P - Standard types

Article number	Comment/footnote on the variant	BSt Ø mm	Bracket spacing e in cm	b1 cm	h cm	lü cm	Packaging piece/pallet	Weight kg/metre
41600815		8	15	6	15	32	200 pieces/pallet	1,740
41600820		8	20	6	15	32	200 pieces/pallet	1,560
41601015		10	15	6	15	39	200 pieces/pallet	2,970
41601020		10	20	6	15	39	200 pieces/pallet	2,410
41080825		8	25	6	15	32	150 pieces/pallet	1,690
41081010		10	10	6	15	39	150 pieces/pallet	4,180
41081215		12	15	8	15	46	150 pieces/pallet	4,690
41081220		12	20	8	15	46	150 pieces/pallet	3,700
41111210		12	10	8	15	46	80 pieces/pallet	7,790
41610815		8	15	8	15	32	200 pieces/pallet	1,740
41610820		8	20	8	15	32	200 pieces/pallet	1,470
41611015		10	15	8	15	39	200 pieces/pallet	2,350
41611020		10	20	8	15	39	200 pieces/pallet	1,910
41800825		8	25	8	15	32	150 pieces/pallet	1,400
41801015		10	15	8	15	39	150 pieces/pallet	3,100
41801210		12	10	8	15	35	150 pieces/pallet	6,550
41801215		12	15	8	15	46	150 pieces/pallet	3,850
41110815		8	15	8	15	32	80 pieces/pallet	3,510
41110820		8	20	8	15	32	80 pieces/pallet	2,890
41110825		8	25	8	15	32	80 pieces/pallet	2,640
41111015		10	15	8	15	39	80 pieces/pallet	5,420
41111020		10	20	8	15	39	80 pieces/pallet	4,340
41111215	Not KOMO certified	12	15	9	15	33	80 pieces/pallet	7,740
41111220	Not KOMO certified	12	20	9	15	46	80 pieces/pallet	6,040
41140815		8	15	11	15	32	108 pieces/pallet	3,550
41140820		8	20	11	15	32	108 pieces/pallet	3,090
41140825		8	25	11	15	32	108 pieces/pallet	2,830
41141010		10	10	11	15	39	108 pieces/pallet	7,560
41141015		10	15	11	15	39	108 pieces/pallet	5,640
41141020		10	20	11	15	39	108 pieces/pallet	4,370
41141215		12	15	11	15	46	108 pieces/pallet	8,010
41141220		12	20	11	15	46	108 pieces/pallet	6,060
41160815		8	15	13	15	32	72 pieces/pallet	3,840
41160820		8	20	13	15	32	72 pieces/pallet	3,370
41160825		8	25	13	15	32	72 pieces/pallet	3,010
41161010		10	10	13	15	39	72 pieces/pallet	7,240
41161015		10	15	13	15	39	72 pieces/pallet	5,440
41161020		10	20	13	15	39	72 pieces/pallet	4,490

COMAX® P - Standard types

Article number	Comment/footnote on the variant	BSt Ø mm	Bracket spacing e in cm	b1 cm	h cm	lü cm	Packaging piece/pallet	Weight kg/metre
41161215		12	15	13	15	46	72 pieces/pallet	7,900
41161220		12	20	13	15	46	72 pieces/pallet	6,340
41190815		8	15	16	15	32	72 pieces/pallet	4
41190820		8	20	16	15	32	72 pieces/pallet	3,550
41190825		8	25	16	15	32	72 pieces/pallet	3,370
41191010		10	10	16	15	39	72 pieces/pallet	7,860
41191015		10	15	16	15	39	72 pieces/pallet	6,150
41191020		10	20	16	15	39	72 pieces/pallet	5,050
41191210		12	10	16	15	46	72 pieces/pallet	13,760
41191215		12	15	16	15	46	72 pieces/pallet	8,550
41191220		12	20	16	15	46	72 pieces/pallet	6,980
41220815		8	15	19	15	32	48 pieces/pallet	4,370
41220820		8	20	19	15	32	48 pieces/pallet	3
41220825		8	25	19	15	32	48 pieces/pallet	3,570
41221010		10	10	19	15	39	48 pieces/pallet	8
41221015		10	15	19	15	39	48 pieces/pallet	6,370
41221020		10	20	19	15	39	48 pieces/pallet	5,320
41221210		12	10	19	15	46	48 pieces/pallet	14,610
41221215		12	15	19	15	46	48 pieces/pallet	8
41221220		12	20	19	15	46	48 pieces/pallet	7
41240815		8	15	21	15	32	48 pieces/pallet	4,740
41240820		8	20	21	15	32	48 pieces/pallet	4,100
41240825		8	25	21	15	32	48 pieces/pallet	3,770
41241010		10	10	21	15	39	48 pieces/pallet	8,730
41241015		10	15	21	15	39	48 pieces/pallet	6,590
41241020		10	20	21	15	39	48 pieces/pallet	5,590
41241210		12	10	21	15	46	48 pieces/pallet	14,800
41241215		12	15	21	15	46	48 pieces/pallet	9,280
41241220		12	20	21	15	46	48 pieces/pallet	7,430
41191415		14	15	16	15	54	60 pieces/pallet	14,490
41221415		14	15	19	15	54	40 pieces/pallet	14,830
41241410		14	10	21	15	54	40 pieces/pallet	22,720
41241415		14	15	21	15	54	40 pieces/pallet	14,880